

VANDIA

Art.-Nr.

405 954
405 955
405 956
405 957

550
550
250
[mm]

1/4
VO
11-2025

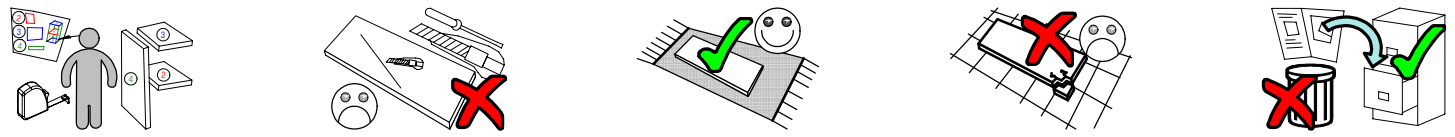
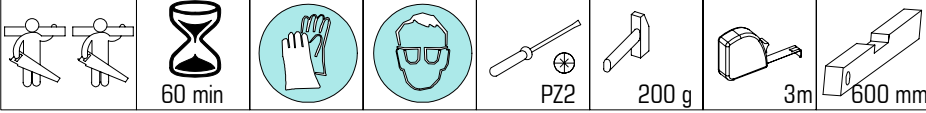

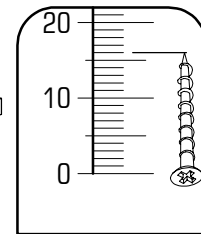
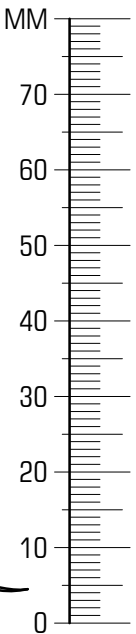
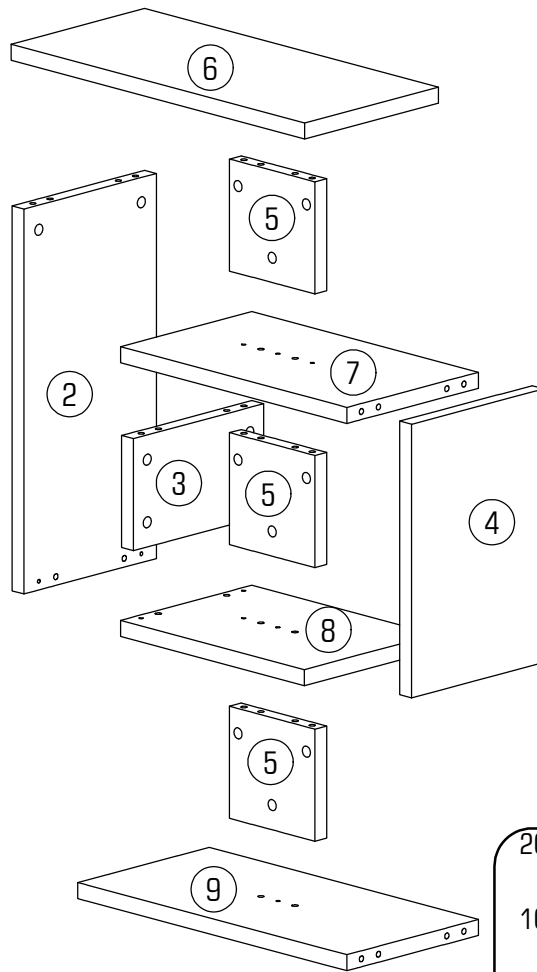
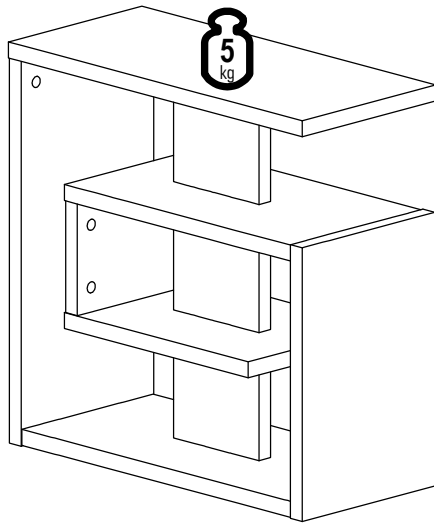

| ID | ID | | | |
|-------|----|------------|----|-----|
| 21983 | ② | 529*248*22 | 1x | 1/1 |
| 21984 | ③ | 154*244*22 | 1x | 1/1 |
| 21985 | ④ | 376*248*22 | 1x | 1/1 |
| 21986 | ⑤ | 154*160*22 | 3x | 1/1 |
| 21987 | ⑥ | 550*250*22 | 1x | 1/1 |
| 21988 | ⑦ | 424*246*22 | 1x | 1/1 |
| 21989 | ⑧ | 344*246*22 | 1x | 1/1 |
| 21990 | ⑨ | 504*246*22 | 1x | 1/1 |





| | | | | | | | |
|---|-----|---|-----|---|-----|---|----|
| | | | | | | | |
| A | 21x | B | 24x | C | 21x | E | 4x |

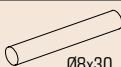

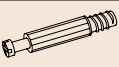
2/4 VANDIA

| | | |
|--|---|---|
|  |  |  |
| B 6x | C 6x | D 15x |

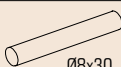

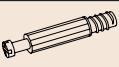
Assembly diagram for step 6-9. Part 6 shows a base plate with 6 screws (D) being inserted. Part 7 shows a second plate being attached to the base with 6 washers (C) and 6 screws (D). Part 8 shows a third plate being attached with 6 washers (C) and 6 screws (D). Part 9 shows a fourth plate being attached with 6 washers (C) and 6 screws (D). A callout shows a hand using a screwdriver to tighten a screw, with a 'MAX 10' torque limit. A warning icon shows a person wearing safety glasses. A warning icon shows a hand using a screwdriver to tighten a screw, with a 'MAX 10' torque limit. A warning icon shows a hand using a screwdriver to tighten a screw, with a 'MAX 10' torque limit. A warning icon shows a hand using a screwdriver to tighten a screw, with a 'MAX 10' torque limit.

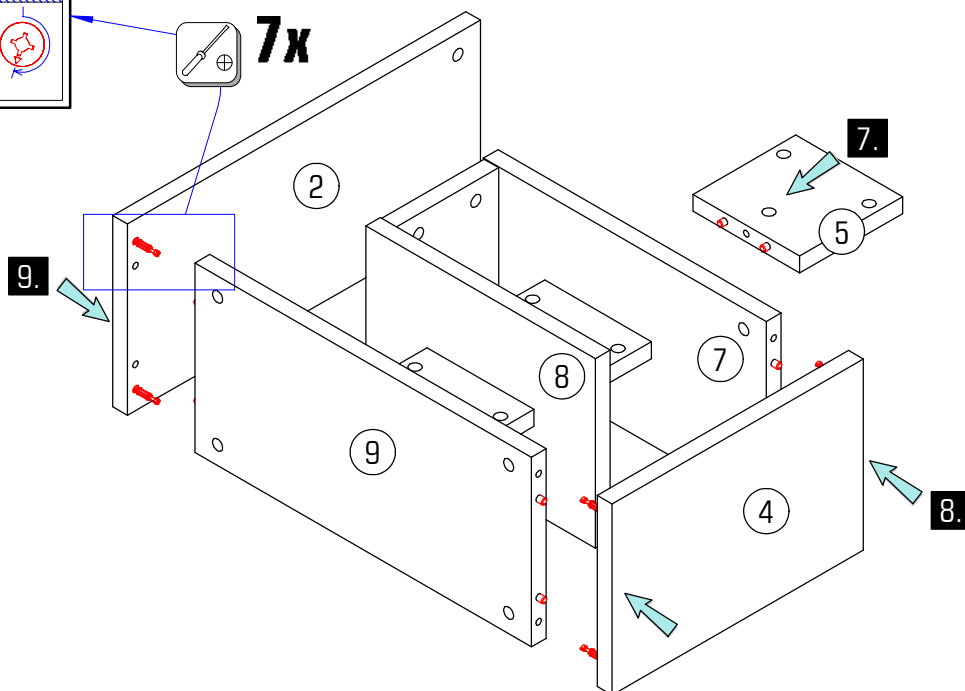
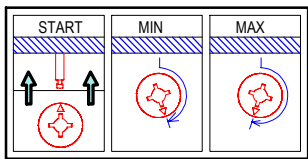
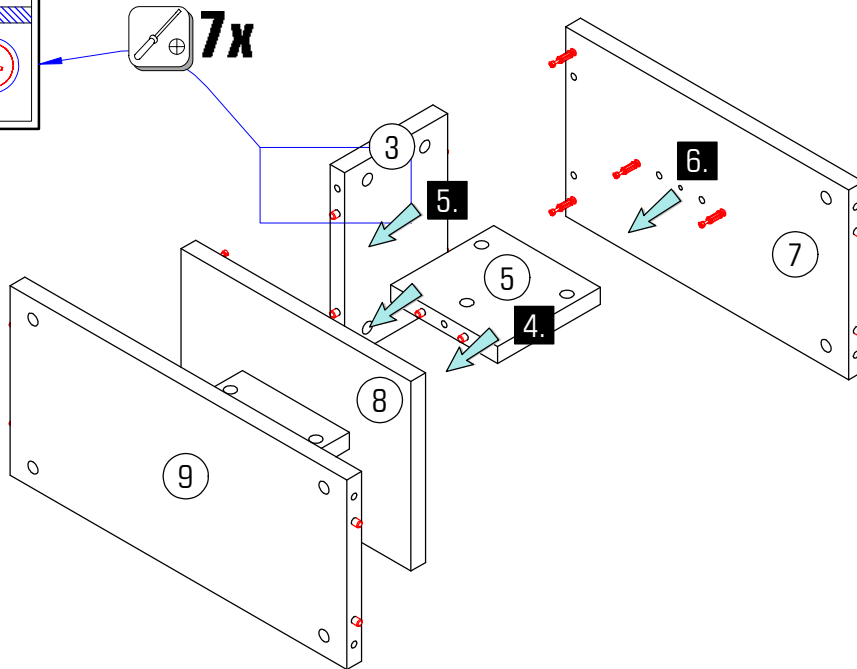
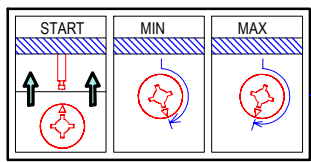
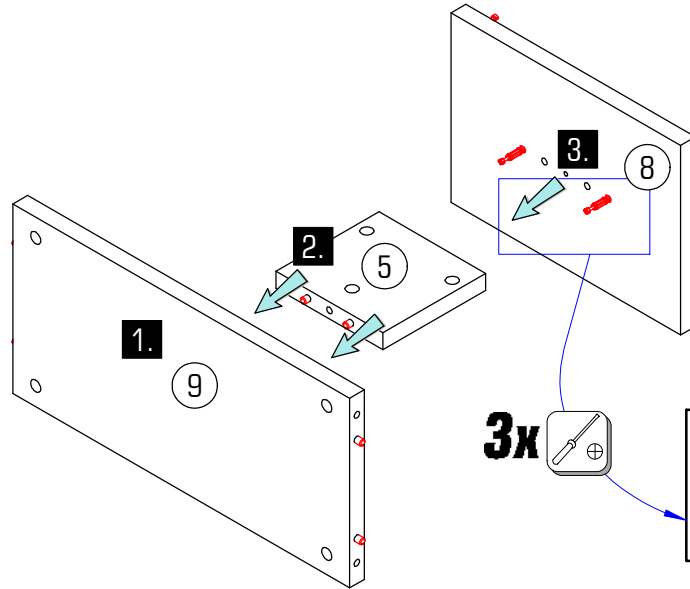
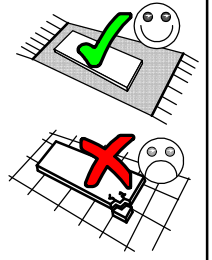

| | | |
|--|---|---|
|  |  |  |
| B 18x | C 15x | D 6x |

Assembly diagram for step 2-5. Part 2 shows a base plate with 6 screws (D) being inserted. Part 3 shows a second plate being attached to the base with 6 washers (C) and 6 screws (D). Part 4 shows a third plate being attached with 6 washers (C) and 6 screws (D). Part 5 shows a fourth plate being attached with 6 washers (C) and 6 screws (D). A callout shows a hand using a screwdriver to tighten a screw, with a 'MAX 10' torque limit. A warning icon shows a person wearing safety glasses. A warning icon shows a hand using a screwdriver to tighten a screw, with a 'MAX 10' torque limit. A warning icon shows a hand using a screwdriver to tighten a screw, with a 'MAX 10' torque limit. A warning icon shows a hand using a screwdriver to tighten a screw, with a 'MAX 10' torque limit.





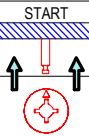



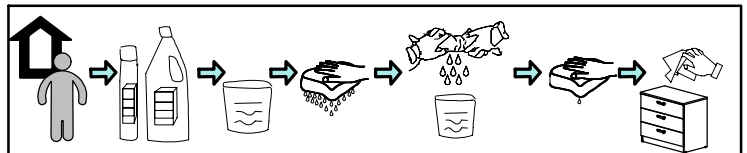
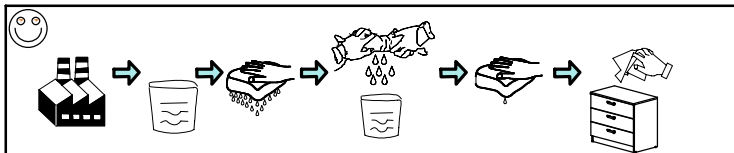
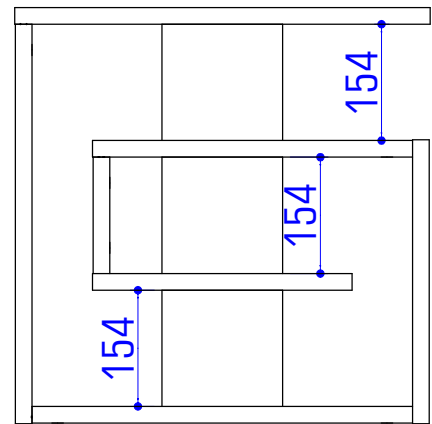
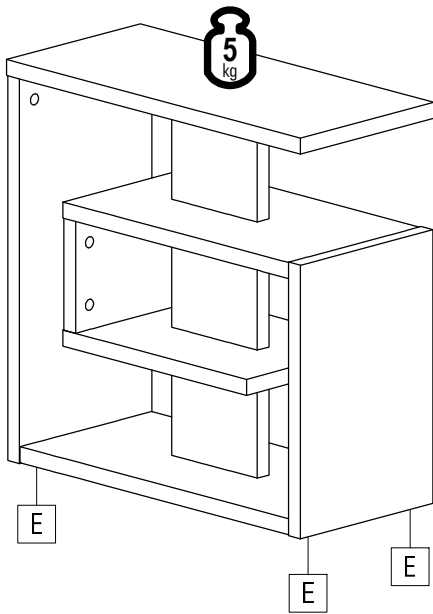
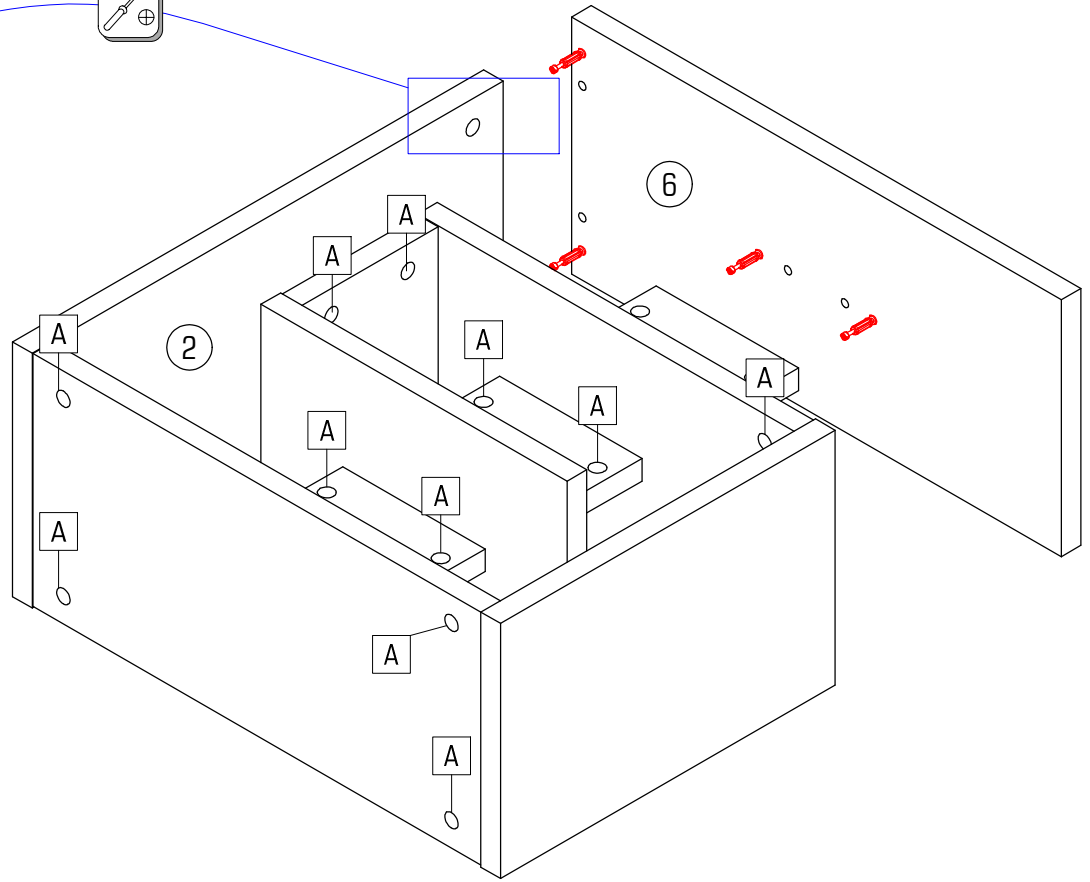

4/4 VANDIA

| | | | |
|---|-----|---|----|
|  | |  | |
| A | 21x | E | 4x |

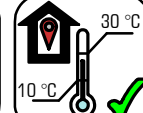
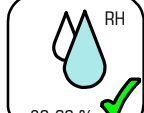
| | | |
|--|---|---|
| START | MIN | MAX |
|  |  |  |

4x

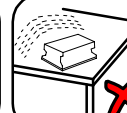

| | | | | | | | | | |
|--|---|---|---|---|---|--|---|---|---|
|  |  |  |  |  |  |  |  |  |  |
|--|---|---|---|---|---|--|---|---|---|